



Masks For Marin City



DIY MASK DRIVE

Donate To: Bayside MLK Jr. Academy | 200 Phillips Drive, Marin City, CA 94965

Currently there is a shortage of masks nationally and globally. The Sausalito Marin City School District with Performing Stars is starting a **DIY MASK DRIVE** to help make masks for Marin City. We are currently taking donations in the form of materials, finished masks, or monetary contributions. Please send all donations or make checks payable to Arts+ physical donations accepted at 200 Phillips Drive, Marin City, CA 94965.

All for ONE and One for All. Be a Masketeer!

During this global pandemic, masks are essential items for everyone to wear while in public spaces because they lower the chances of the **COVID-19** entering your respiratory system through droplets infected with the virus that can easily be passed through a simple cough or sneeze.

We have included 4 DIY MASK tutorials that you can create at home using **NO-SEW** and **SEWING TECHNIQUES** if you wish to donate to our **DIY MASK DRIVE**.



100% COTTON IS RECOMMENDED

Any used cotton cloth including old cotton vest or t-shirt can be used to make these mask. Remember the color of the mask does **NOT** matter. You must ensure that the fabric is washed well in boiling water for 5 minutes and dried well, before you make the mask. Adding salt to this water is also recommended to help sanitize the cloth.

EASY Cut T-shirt Face Covering (No Sew Method)

Materials Needed: T-Shirt & Scissors

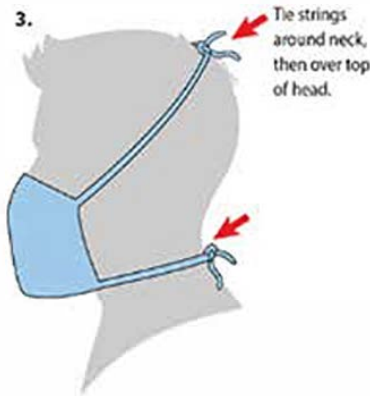
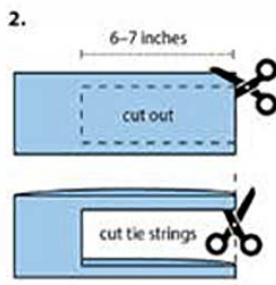
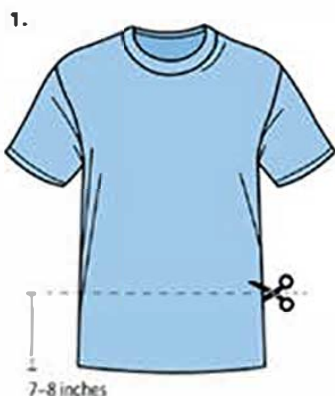



Masks For Marin City

DIY MASK DRIVE



All for ONE and ONE for All. Be a Masketeer!

Donate To: Bayside MLK Jr. Academy | 200 Phillips Drive, Marin City, CA 94965

Bandana Face Covering (No Sew Method)

Materials Needed:

- Bandana (or square cotton cloth approximately 20"x20")
- Coffee filter
- Rubber bands (or hair ties)
- Scissors (if you are cutting your own cloth)



1.

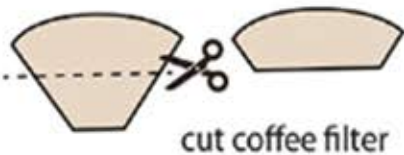

2.

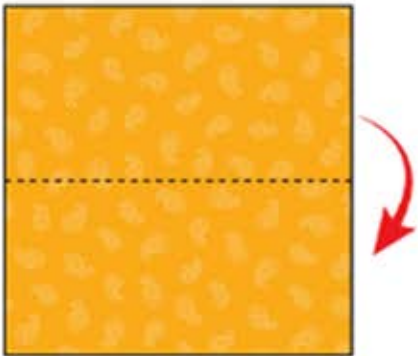

3.



Fold filter in center of folded bandanna.
Fold top down. Fold bottom up.

4.



Place rubber bands or hair ties about 6 inches apart.

5.

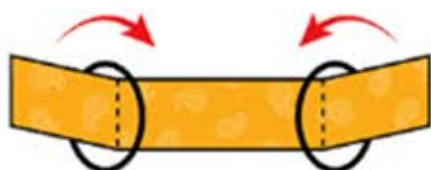

Fold side to the middle and tuck.

6.



7.

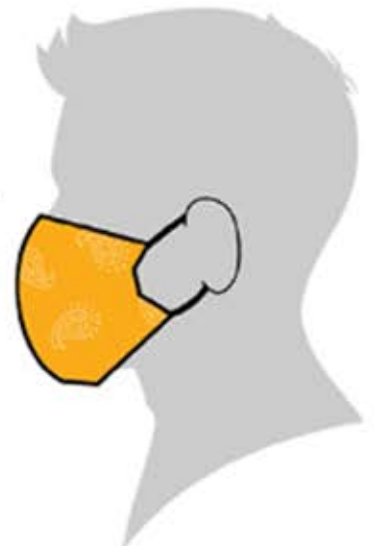



Masks For Marin City

DIY MASK DRIVE

All for ONE and ONE for All. Be a Masketeer!



Donate To: Bayside MLK Jr. Academy | 200 Phillips Drive, Marin City, CA 94965

Tucked Cloth Face Mask (Sewing Method)

Materials Needed:

- Two 10"x6" rectangles of cotton fabric
- Two 6" pieces of elastic (or rubber bands, string, cloth strips, or hair ties)
- Needle and thread (or bobby pin)
- Scissors
- Sewing machine

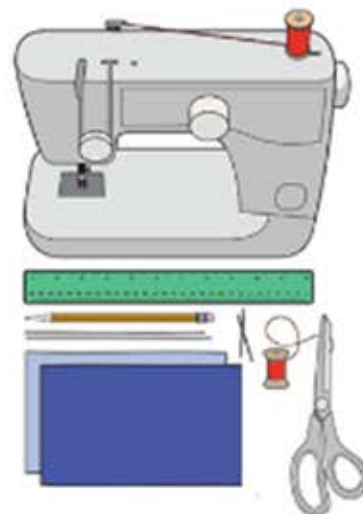

1. Cut out two 10-by-6-inch rectangles of cotton fabric. Use tightly woven cotton, such as quilting fabric or cotton sheets. T-shirt fabric will work in a pinch. Stack the two rectangles; you will sew the mask as if it was a single piece of fabric.

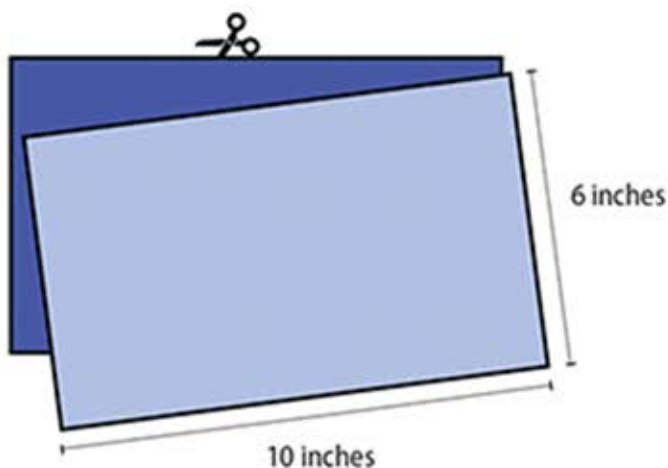

2. Fold over the long sides $\frac{1}{4}$ inch and hem. Then fold the double layer of fabric over $\frac{1}{2}$ inch along the short sides and stitch down.

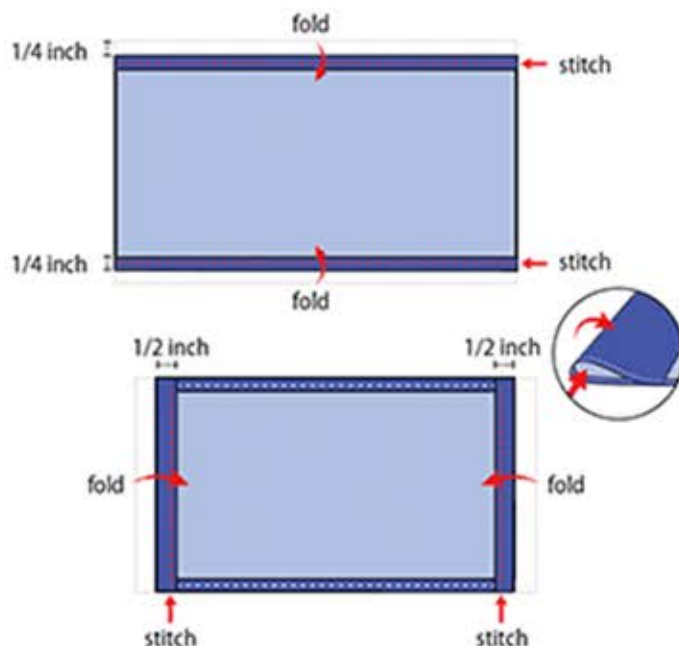



Masks For Marin City

DIY MASK DRIVE

All for ONE and ONE for All. Be a Masketeer!



Donate To: Bayside MLK Jr. Academy | 200 Phillips Drive, Marin City, CA 94965

Tucked Cloth Face Mask (Sewing Method)

Materials Needed:

- Two 10"x6" rectangles of cotton fabric
- Two 6" pieces of elastic (or rubber bands, string, cloth strips, or hair ties)
- Needle and thread (or bobby pin)
- Scissors • Sewing machine

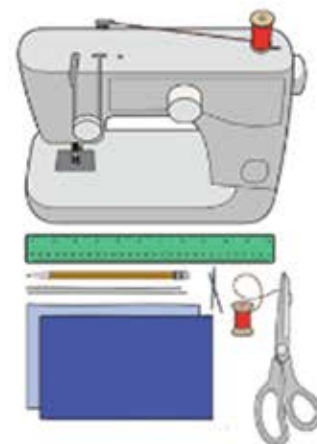

3. Run a 6-inch length of 1/8-inch wide elastic through the wider hem on each side of the mask. These will be the ear loops. Use a large needle or a bobby pin to thread it through. Tie the ends tight. Don't have elastic? Use hair ties or elastic head bands. If you only have string, you can make the ties longer and tie the mask behind your head.

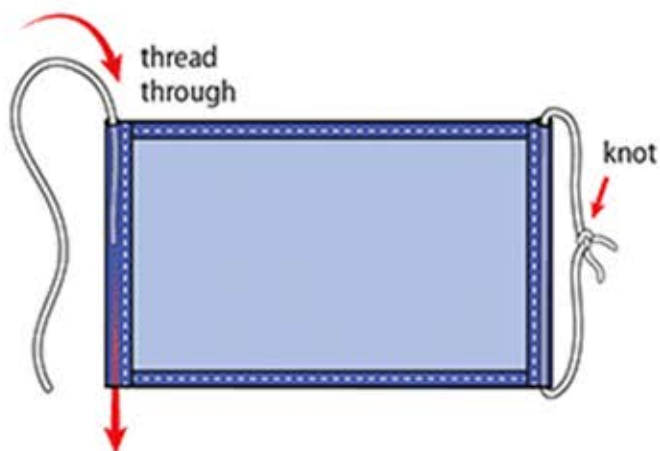

4. Gently pull on the elastic so that the knots are tucked inside the hem. Gather the sides of the mask on the elastic and adjust so the mask fits your face. Then securely stitch the elastic in place to keep it from slipping.

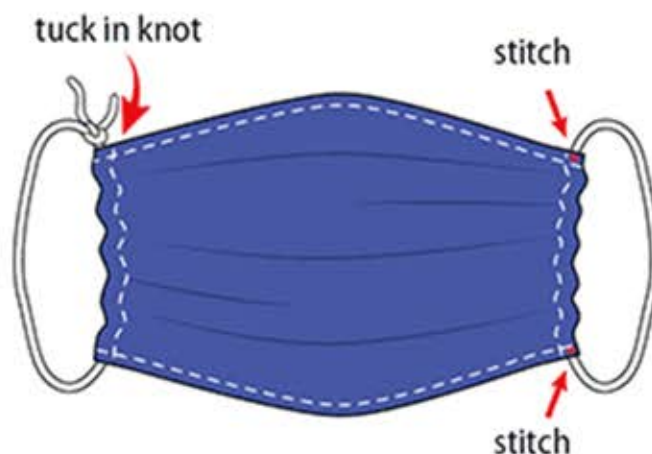



Masks For Marin City

DIY MASK DRIVE



All for ONE and ONE for All. Be a Masketeer!

Donate To: Bayside MLK Jr. Academy | 200 Phillips Drive, Marin City, CA 94965

Craft Passion Cloth Face Mask (Sewing Method)

Link: <https://www.craftpassion.com/face-mask-sewing-pattern/#face-mask-pattern>

Materials + Tools Needed:

- Cotton fabric, 13" x 7" (Main Fabric) prewash
- Cotton fabric, 12" x 7" (Lining Fabric) prewash
- Elastic cord for ear loops 16", or shoelace/ribbon/
cord/thick yarn with at least 44" length for head tie
- Sewing machine or hand sew
- Iron
- Pencil or fabric marker
- Seamstress traing wheel and paper





Masks For Marin City

DIY MASK DRIVE



All for ONE and ONE for All. Be a Masketeer!

Donate To: Bayside MLK Jr. Academy | 200 Phillips Drive, Marin City, CA 94965

Craft Passion Cloth Face Mask (Sewing Method)

Link: <https://www.craftpassion.com/face-mask-sewing-pattern/#face-mask-pattern>

Print template and cut out the template you want to make.

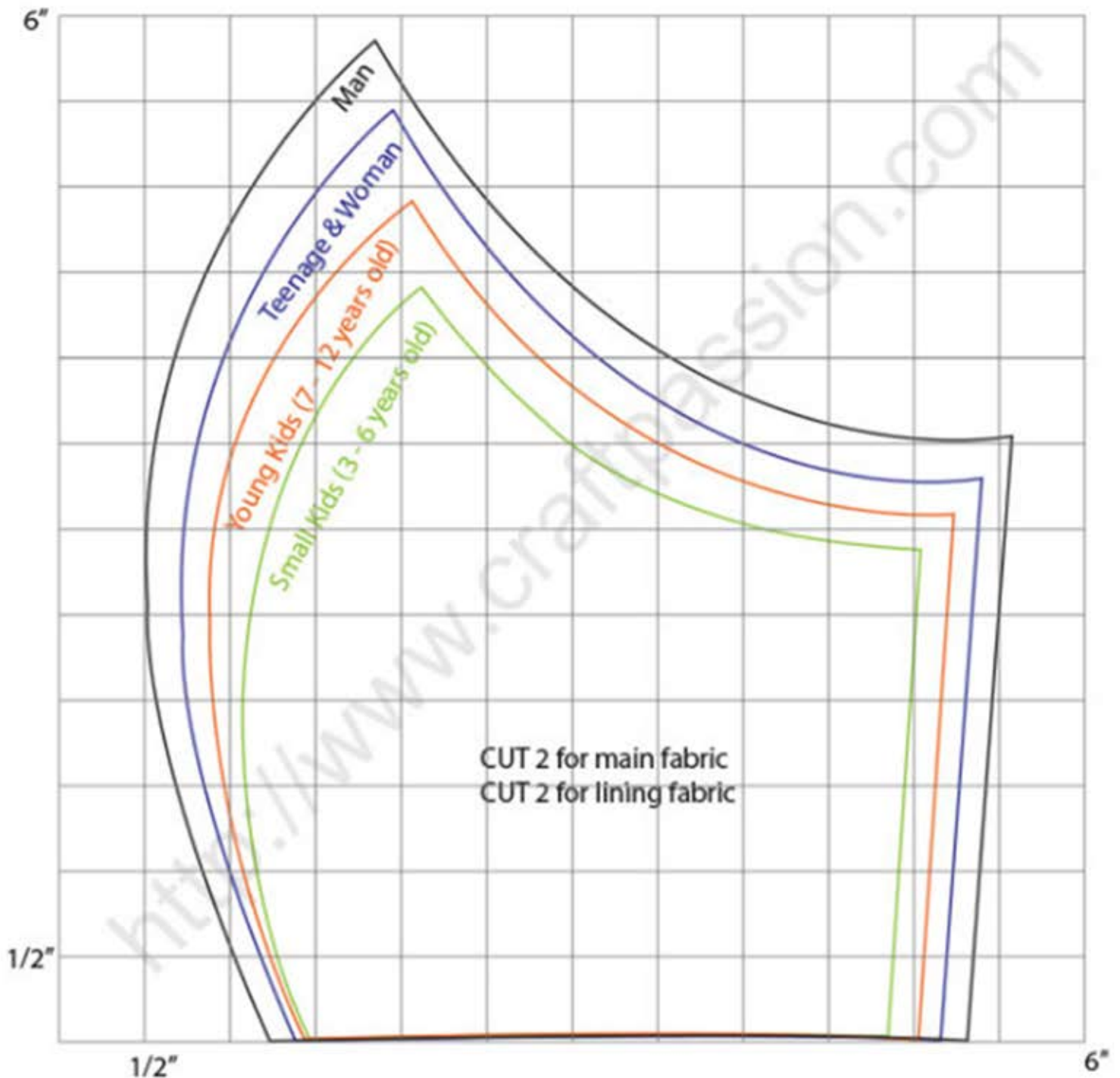

Masks For Marin City

DIY MASK DRIVE

All for ONE and ONE for All. Be a Masketeer!

Donate To: Bayside MLK Jr. Academy | 200 Phillips Drive, Marin City, CA 94965

Craft Passion Cloth Face Mask (Sewing Method)

Link: <https://www.craftpassion.com/face-mask-sewing-pattern/#face-mask-pattern>

Step A-1. Fold the main fabric into halve with the wrong side facing each other, pin the paper pattern onto the double-layered fabric. Cut the fabric with 1/4" allowance, except the ear side. Cut the fabric at the ear side with 1" seam allowance.

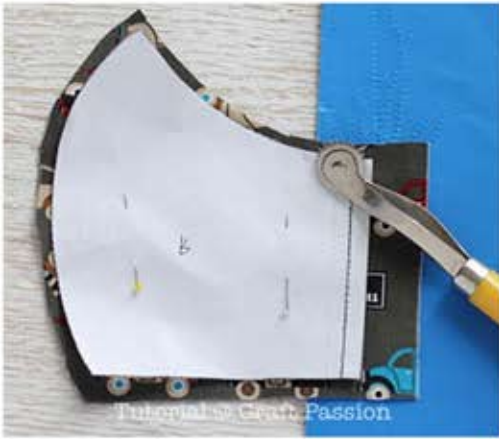

Insert the tracing paper between the layer, trace sewing lines with tracing wheel. Remove pins and paper pattern, get set to sew.

NOTE: If you are using templates that already have seam allowances included, you do not need to add any more seam allowance. The same applies to the lining in the next step.

Step A-2.



Repeat the same as the main fabric, except the ear side seam allowance. Cut the fabric at the ear side with zero seam allowance.

Step A-3.



Turn the face mask main piece with right side facing each other, sew the centerline of the face mask.



Masks For Marin City

DIY MASK DRIVE

All for ONE and ONE for All. Be a Masketeer!



Donate To: Bayside MLK Jr. Academy | 200 Phillips Drive, Marin City, CA 94965

Craft Passion Cloth Face Mask (Sewing Method)

Link: <https://www.craftpassion.com/face-mask-sewing-pattern/#face-mask-pattern>

Step A-4.



Clip curve along with the seam allowance, be careful and don't accidentally clip on the stitches.

Step A-5.



Press seam allowance to one side, topstitch near to the seam line on the side where the seam allowance is.

Step A-6.



Repeat the sewing on the lining part.

Step A-7.



Flip the lining and place onto the main face mask, align the center seam line, pin and sew the top and bottom lines.



Masks For Marin City

DIY MASK DRIVE

All for ONE and ONE for All. Be a Masketeer!



Donate To: Bayside MLK Jr. Academy | 200 Phillips Drive, Marin City, CA 94965

Craft Passion Cloth Face Mask (Sewing Method)

Link: <https://www.craftpassion.com/face-mask-sewing-pattern/#face-mask-pattern>

Step A-8.



Turn the face mask right side out. Press seam neatly and topstitch near the edge.

Step A-10.



Step A-9.



This is how it looks like from the inside at this stage. The main fabric of the side ear area is longer than the lining piece. This is going to be the pocket of the elastic band.

Fold in 1/4" at the raw edge of the side ear, fold again so that the first fold edge is 1/4" from the lining raw edge.

Sew a straight line down, don't forget to perform a few back stitches to lock the thread end.



Masks For Marin City

DIY MASK DRIVE

All for ONE and ONE for All. Be a Masketeer!



Donate To: Bayside MLK Jr. Academy | 200 Phillips Drive, Marin City, CA 94965

Craft Passion Cloth Face Mask (Sewing Method)

Link: <https://www.craftpassion.com/face-mask-sewing-pattern/#face-mask-pattern>

Step A-11.



Measure and cut the length of the elastic band needed (usually around 6"-8" depending on the size of the face).

Insert the elastic band through the pocket and tie a dead knot to the ends.

Step A-12.



Repeat the same to the other side. Pull the elastic band until the knots are hidden in the pocket.

Wear and breathe normally!